

Data Sheet



Article number: 58MI10S0020CAP

Description: Cylinder MI-10x20-S-CA, Ø10x20
Double acting type - port M5

Measures

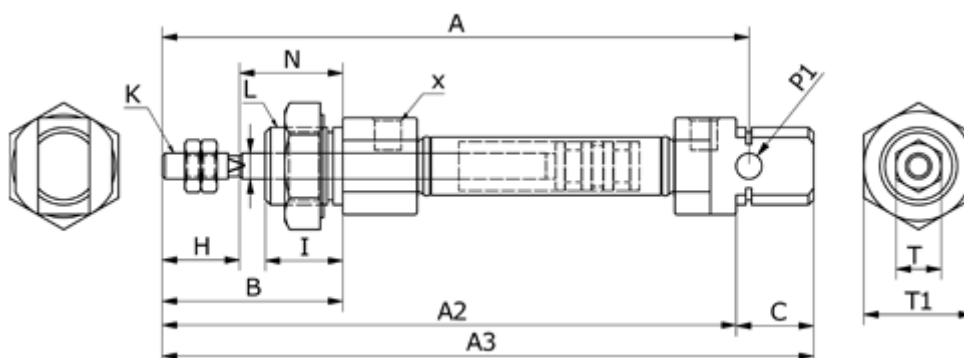

A	= 76	K	= M4x0,7	V = 4
A2	= 46	L	= M12x1,25	X = M5x0,8
A3	= 86	N	= 16	
B	= 28	O	= 10	
Bore diameter	= 10	P1	= 4	
C	= 12	Stroke	= 20	
HS	= 12	T	= 7	
I	= 12	T1	= 17	